

Last Name: _____

First Name: _____

Physics 102 Spring 2006: Exam 1—Free Response and Instructions

- Print your LAST and FIRST name on the front of your blue book, on this question sheet, the multiple-choice question sheet and the multiple-choice answer sheet.
- TIME ALLOWED 90 MINUTES
- The test consists of two free-response questions and 15 multiple-choice questions.
- The test is graded on a scale of 100 points; free-response question I counts for 35 points, free-response II counts for 20 points, and the multiple-choice questions account for 45 points (three points each).
- Answer the two free-response questions in your blue book. Answer the multiple-choice questions by marking a dark X in the appropriate column and row in the table on the multiple-choice answer sheet.
- Consult no books or notes of any kind. You may use a hand-held calculator in non-graphing, non-programmed mode.
- Do NOT take test materials outside of the class at any time. Return this question sheet along with your blue book and multiple-choice question sheet.
- Write and sign the Pledge on the front of your blue book.

Show your work for the free-response problems, including neat and clearly labelled figures, in your blue book. Answers without explanation (even correct answers) will not be given credit.

I. (35 pts) A conducting spherical shell has inner radius a and outer radius b . The shell carries a total charge $+2Q$. Concentric to this spherical shell is a second, larger spherical shell of inner radius c and outer radius d . The outer shell carries zero net charge. The coordinate r measures the distance from the center of the inner shell.

- 4 (a) What are the charges on each of the four conducting surfaces?
- 11 (b) Determine the electric field $\vec{E}(r)$ for all values of r .
- 47 (c) Sketch $\vec{E}(r)$ vs. r for all r .
- 12 (d) Taking the zero of the electrostatic potential $V(r)$ to be zero at $r = \infty$, determine $V(r)$ for all r .
- 41 (e) Sketch $V(r)$ vs. r for all values of r .

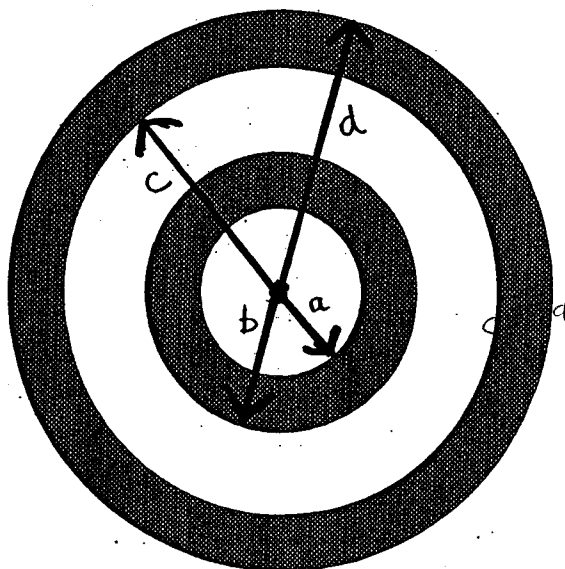

II. (20 pts) A point charge of magnitude $+2Q$ is located on the x -axis at $x = b$. A very long, thin wire carrying a uniform charge density $-\lambda$ is parallel to the x -axis, located at $y = 2b$.

- 8 (a) Determine the electric field $\vec{E}(x)$ for every point on the x -axis.
7 (b) How much work must be done to move a small test charge $+q$ along the x -axis from $x = 10b$ to $x = 3b$?
5 (c) A Gaussian sphere of radius $b/2$ is centered at the origin. Determine the electric flux Φ_E through this surface.

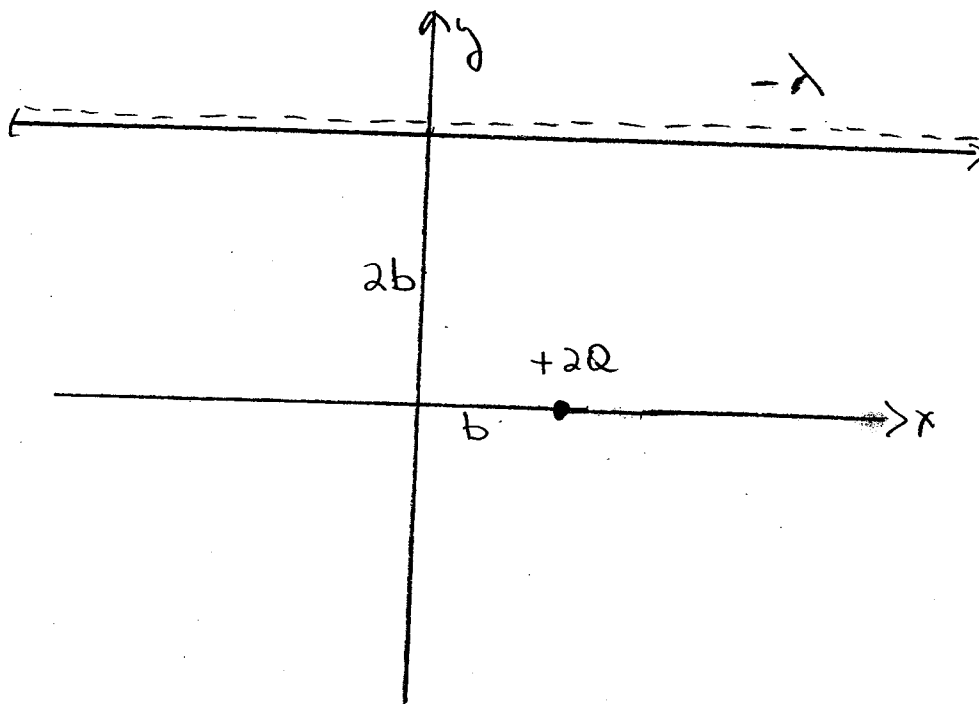

Last Name:

First Name:

Physics 102 Spring 2006: Exam #1 —Multiple-Choice Questions

1. Consider two isolated spherical conductors each having net charge Q . The spheres have radii a and b , where $b > a$. Which sphere has the higher potential? (Take the zero of potential to be at ∞ .)
- (a) the sphere of radius a .
 - (b) the sphere of radius b .
 - (c) they have the same potential.
 - (d) more information is needed to answer the question.
2. Rank the work required to assemble the charge distributions below from least to greatest. In all cases, the separation between the middle charge and the outer charges are the same. Use a reference of zero potential energy at ∞ .

- (a) $A < B < C = D$
- (b) $C = D < B < A$
- (c) $A < B = C = D$
- (d) $B = C = D < A$
- (e) $D < C = B < A$

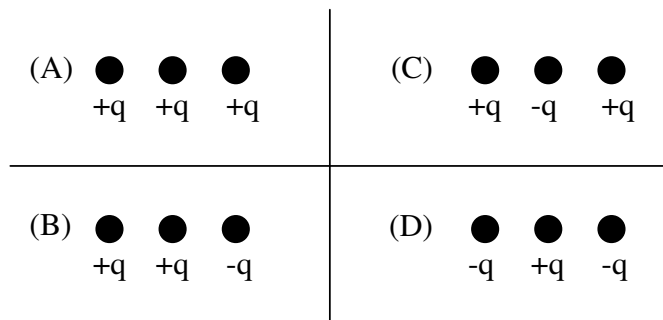

3. A positive charged particle traveling with a velocity \vec{v} in an electric field \vec{E} experiences a force \vec{F} that must be
- (a) parallel to \vec{v} .
 - (b) parallel to \vec{E} .
 - (c) perpendicular to \vec{v} .
 - (d) parallel to $\vec{v} \times \vec{E}$.
 - (e) perpendicular to \vec{E} .

For questions 4 and 5, refer to the graph below, depicting the potential on the x -axis as a function of x

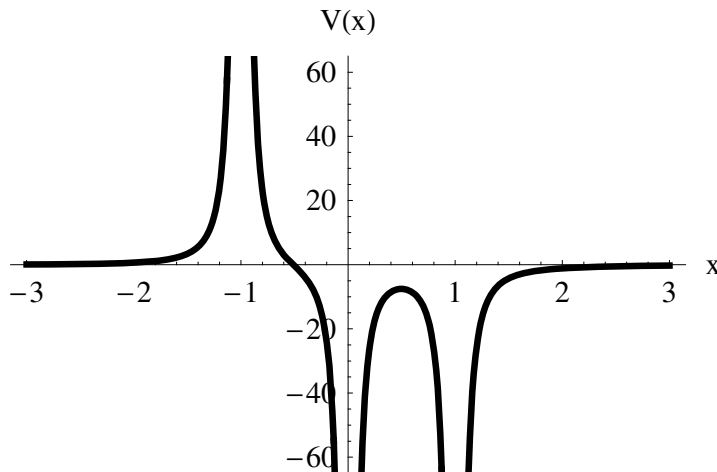

4. Which of the charge configurations depicted below would give rise to the potential shown above?

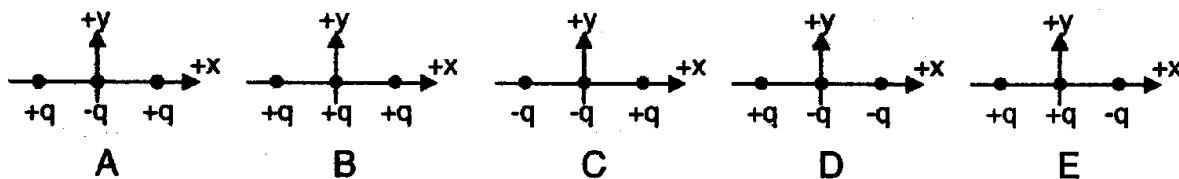

5. What is the x component of the electric field for points on the x -axis given by the potential depicted above?

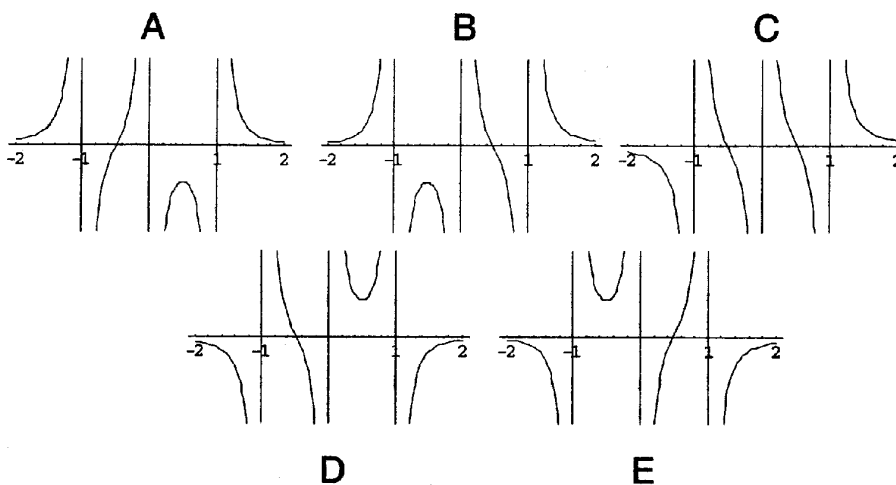

6. Consider a metal cylindrical shell of outer radius r_c and inner radius r_b which is concentric with a metal wire of radius r_a . The linear charge density of the wire is $+\lambda$ and linear charge density of the cylinder is $-\lambda$. Which of the following statement(s) is (are) true?

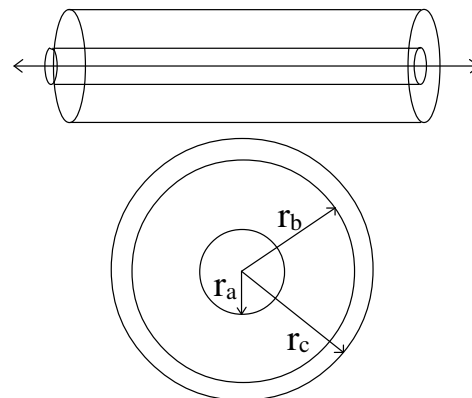

- I. The potential difference between r_c and r_b is zero.
- II. The potential difference between r_b and r_a is zero.
- III. The potential difference between a point outside the cylinder and r_c is zero.
- IV. The electric field between a point outside the cylinder and r_c is zero.

- (a) only I and IV are true
 - (b) only II and IV are true
 - (c) only I and III are true
 - (d) only II, III and IV are true
 - (e) only I, III, and IV are true
7. What is the direction of the electric field of the charge distribution below at the points 1, 2, and 3?
(Note: points 1 and 2 are on the line bisecting the segment connecting the charges.)

1

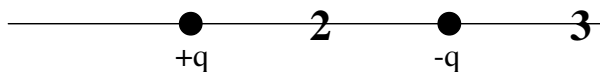

- | | | |
|---------------------------|----------------------|----------------------|
| (A). 1: \longrightarrow | 2: 0 | 3: \longrightarrow |
| (B). 1: \uparrow | 2: \longrightarrow | 3: 0 |
| (C). 1: \longrightarrow | 2: \longrightarrow | 3: \longleftarrow |
| (D). 1: 0 | 2: 0 | 3: \longleftarrow |
| (E). 1: \longrightarrow | 2: 0 | 3: \longleftarrow |

8. A net charge of $+Q$ is transferred to a spherical conducting shell of inner radius a and outer radius b . A point charge $-10q$ is placed in the center of the shell (as shown below). What is the charge density on the outside of the conducting shell?

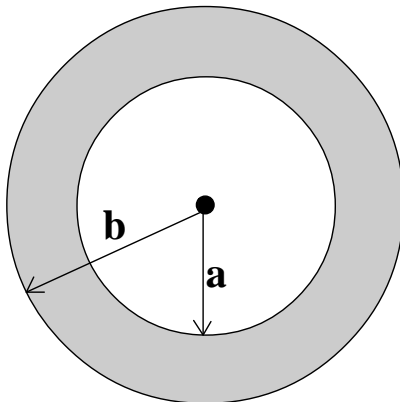

- (a) $\sigma = -10q/4\pi b^2$.
(b) $\sigma = -Q/4\pi b^2$.
(c) $\sigma = (Q - 10q)/4\pi b^2$.
(d) $\sigma = (Q + 10q)/4\pi b^2$.
(e) $\sigma = (10q - Q)/4\pi b^2$.
9. Charges $+Q$ and $+4Q$ are situated as shown below. The net electric field is zero nearest which point?

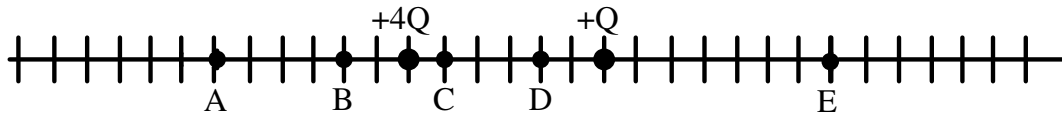

- (a) A.
(b) B.
(c) C.
(d) D.
(e) E.

10. An electron enters a region which is known to have a uniform electric field. If the electron leaves the region a distance d lower than it entered the region, as shown below, which vector best represents the electric field vector in the specified region?

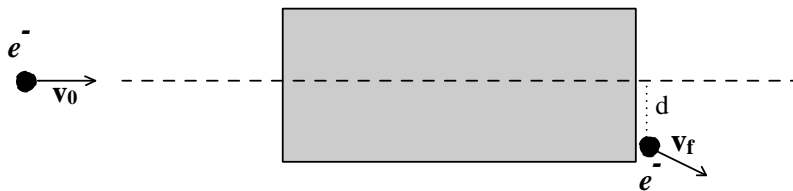

- (a) \downarrow
- (b) \uparrow
- (c) \leftarrow
- (d) \otimes (directed into the page)
- (e) \odot (directed out of the page)

11. A charge $q = -6Q$ rests inside a pyramid as shown in the figure below. The pyramid has a lateral base perimeter of a units and a lateral base height of b units. What is the total electric flux through the pyramid?

- (a) $\Phi = \frac{-3kQ}{b^2}$
- (b) $\Phi = \frac{-6Q}{\epsilon_0}$
- (c) $\Phi = \frac{-6Qa^2}{b^2\epsilon_0}$
- (d) $\Phi = \frac{-3Qa^2b^2}{\epsilon_0}$
- (e) $\Phi = \frac{-6kQ}{a^2}$

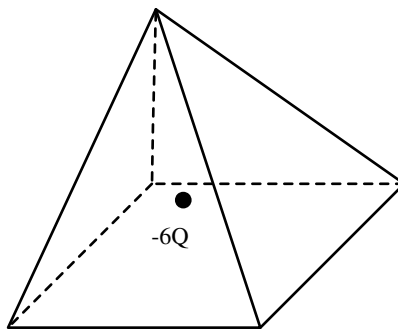

12. The figure below depicts four charges, three with positive charge $+q$ and one with negative charge $-q$, placed at the corners of a square. Which arrow below most accurately depicts the force on a negatively charged particle at the center point C ?

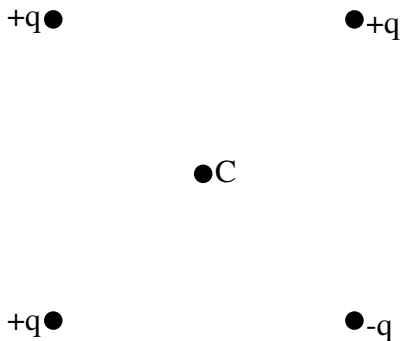

- (a)
- (b)
- (c)
- (d)
- (e) 0

13. Three equal charges are placed at the corners of an equilateral triangle. Which of the graphs below correctly depicts the equally-spaced equipotential surfaces in the plane of the triangle? (All graphs have the same scale.)

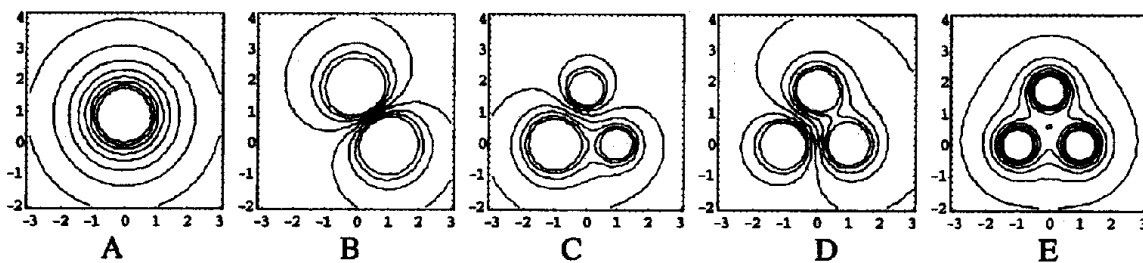

- (a) A.
- (b) B.
- (c) C.
- (d) D.
- (e) E.

14. Positive charge $+Q$ is uniformly distributed on the upper half of a semicircular rod and negative charge $-Q$ is uniformly distributed on the lower half, as shown in the figure below. Which arrow best indicates the direction of the electric field at point P, the center of the semicircle?

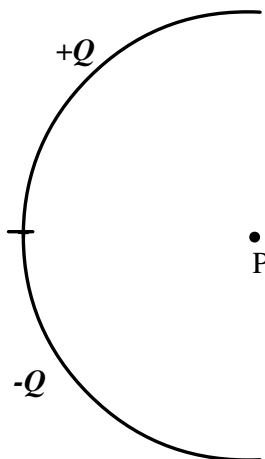

- (a) ↓
(b) ↑
(c) ←
(d) →
(e) 0
15. A point charge Q is held fixed in place and another point charge q is brought closer to it moving at constant velocity. Which of the following statement(s) is (are) true?
- I. The electrostatic potential energy of q increases as it is brought closer to Q if q and Q are of the same sign.
II. The work done by the electrostatic force is positive if q and Q are of the same sign.
III. The work done by an external force to bring q closer to Q is positive if q and Q are of the opposite sign.
IV. The work done by an external force to bring q closer to Q is negative if q and Q are of the opposite sign.
- (a) I only.
(b) II only.
(c) I and II only.
(d) I and IV only.
(e) II and III only.